

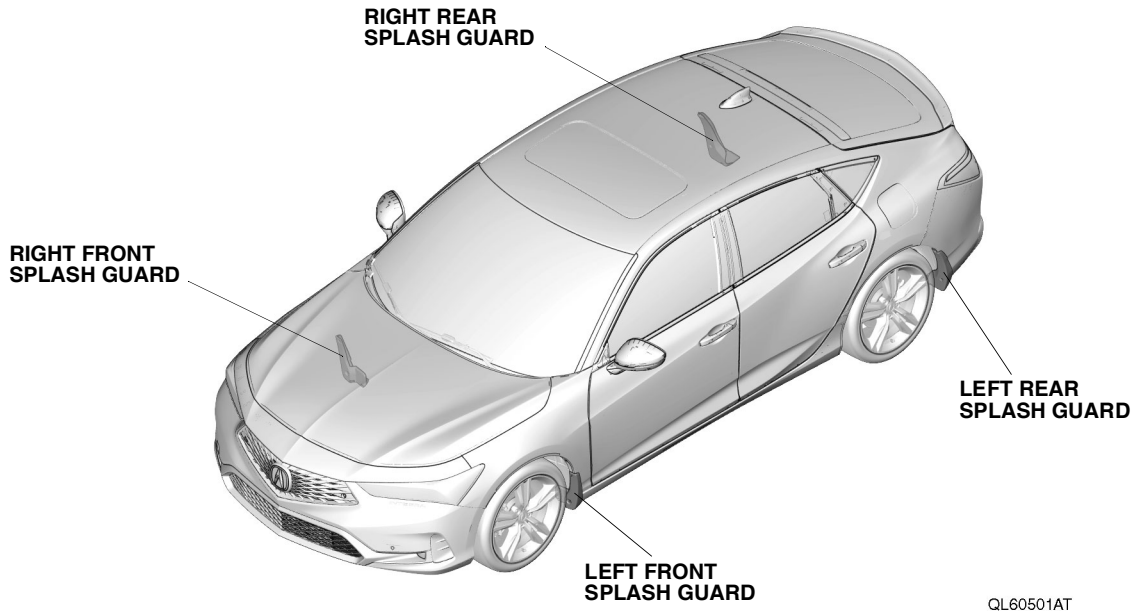

INSTALLATION INSTRUCTIONS

Accessory SPLASH GUARDS	Application 2023 INTEGRA MODEL SERIES	Publications No. VERSION 1
		Issue Date MAY 2022

GENERAL VIEW



FOR YOUR SAFETY (Read carefully.)

Warning Symbols

Safety: Your safety, and the safety of others, is important. To help you make informed decisions about service procedures, we have provided safety messages where appropriate. Of course, it is not practical or possible to warn you about all the hazards associated with servicing a vehicle - you must use your own good judgment.

You will find important safety messages preceded by one of following symbols:

*All symbols are not used in all installation instructions.

⚠ DANGER

You will be killed or seriously hurt if you do not follow the instructions.

⚠ WARNING

You can be killed or seriously hurt if you do not follow the instructions.

⚠ CAUTION

You can be hurt if you do not follow the instructions.

NOTICE

Gives advice to prevent damage to the product, vehicle, the environment or other property.

NOTE

Gives helpful information or instructions to be followed when installing this product.



Indicates a prohibited action.

Procedure and Location Icons

These icons indicate the work location and the worker's point of view.

*All icons are not used in all installation instructions.

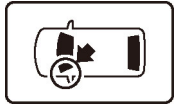

The location on the vehicle.

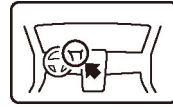

The location in the vehicle.
(instrument panel.)



Wear eye protection.



Wear heavy gloves.



Use an assistant.



Place the part on a blanket.



Work perpendicular.



Remove any burrs.



Use touch-up paint and allow to dry.



Tighten to the specified torque.



Apply firm pressure while rolling, especially at the ends, to set the adhesive.



Press firmly.



Clean with isopropyl alcohol.



Return the original part to the client.
(Do not reuse.)

Safety: General







- Observe all safety notes and precautions described in the service information, in addition to those described in this Installation Instruction. Be extremely careful for your safety and the safety of others.
- Be careful not to damage the vehicle or the parts.
- Note the locations of the parts before removing them so they can be properly installed in their original positions.
- The illustrations may differ slightly from the actual accessory.

Safety: Accessory

Always use the parts and tools specified in the installation instructions.

PARTS LIST

Splash Guard Kit (P/N 08P00-3S5-200)

Right front splash guard	Left front splash guard	Right rear splash guard	Left rear splash guard
			
Self-tapping screws (6)	Spring nuts (2)		
			

REQUIRED TOOLS AND SUPPLIES

- Pushpin
- Ruler
- Phillips screwdriver
- Utility knife
- Stubby Phillips screwdriver
- File

5. Remove the self-tapping screws.

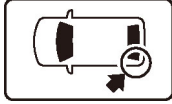

6. Cut the left rear fender cover.

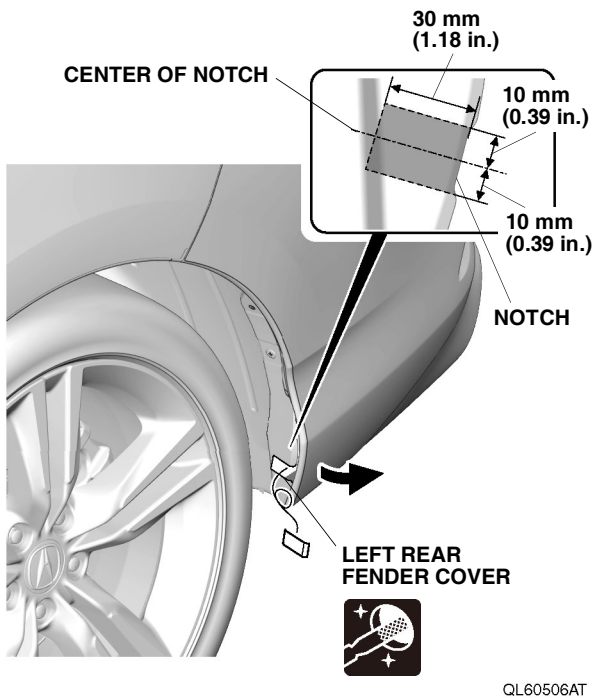

7. Install the spring nut.

NOTICE

Make sure to install the spring nut in the correct orientation.

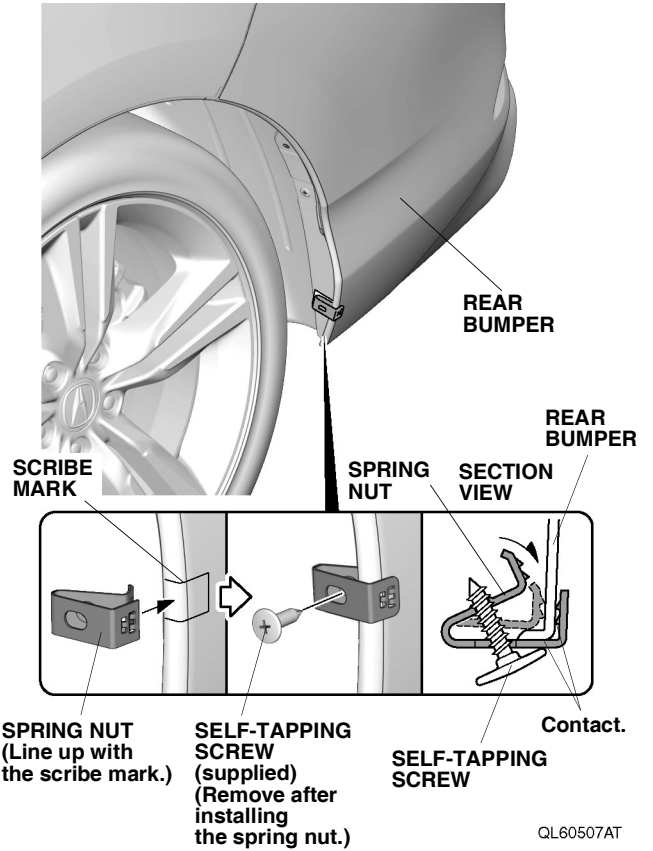

8. Remove the self-tapping screw.

9. Install the left rear splash guard.

NOTE

- Install in the order shown.
- Make sure that there is no gap between the splash guard and vehicle body. If there is a gap, loosen the self-tapping screws, hold the splash guard against the vehicle body, and retighten the screws.
- Make sure that the splash guard is properly installed.

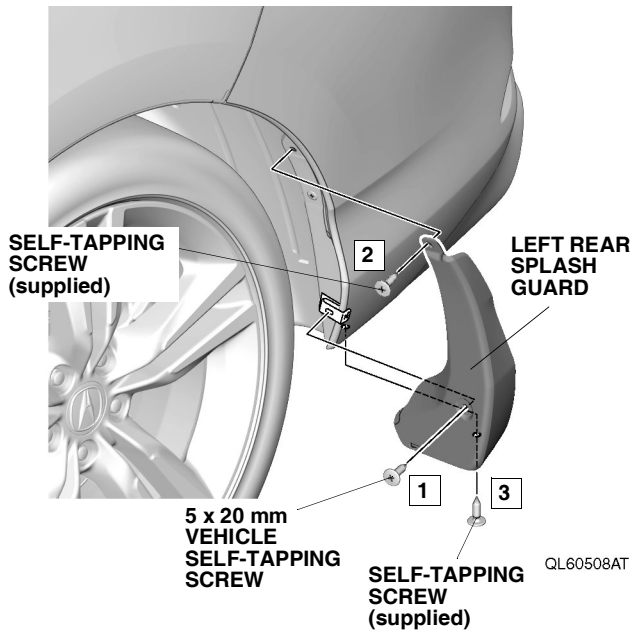

10. Turn the steering wheel fully clockwise, and repeat the same procedures on the other side.

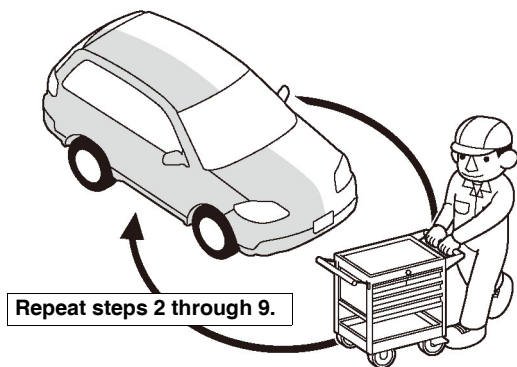

Q9D1014AM

11. Check that all parts are installed properly.